

Rochester Gas and Electric Corporation
Application To
Construct a Fuel Gas Transmission Line Under Article VII, Section 121-a of
The Public Service Law

CM-1 & CM-4 Replacement Project
Gas Distribution Line
Town of Chili, Monroe County, New York

Exhibit G

Agricultural Mitigation Through the Stages of Project Planning, Construction/Restoration and Follow-up Monitoring

PIPELINE RIGHT-OF-WAY CONSTRUCTION PROJECTS

AGRICULTURAL MITIGATION
THROUGH THE STAGES OF PROJECT PLANNING,
CONSTRUCTION/RESTORATION AND FOLLOW-UP MONITORING

By
New York State
Department of Agriculture and Markets
Albany, New York

NYS DEPT. OF AGRICULTURE AND MARKETS

Division of Agricultural Protection and Development Services:

Matthew Brower
Agricultural Resource Specialist
NYS Dept. of Agriculture and Markets
10B Airline Drive
Albany, NY 12235-0001
Phone (518) 457-2713
Telefax (518) 457-2716
Email: matthew.brower@agmkt.state.ny.us

Michael Saviola
Agricultural Resource Specialist
NYS Dept. of Agriculture and Markets
Administration Building Suite 201
900 Jefferson Road
Rochester, NY 14623
(607)351-7954
Email: michael.saviola@agmkt.state.ny.us

Counsel's Office:

Diane Smith
Associate Attorney
NYS Dept. of Agriculture and Markets
10B Airline Drive
Albany, NY 12235-0001
Phone (518) 457-4111
Telefax (518) 457-8842

1.0 INTRODUCTION

The following agricultural mitigation standards are designed to apply to transmission pipelines that affect agricultural land. These standards and practices apply to the early planning stage of the project through construction, restoration, and post-construction monitoring and rehabilitation. The specific details regarding “Agricultural and Soil Conservation Specialists/Inspectors”, in addition to the traditional environmental specialists, apply to projects of significant length or projects of relatively moderate length, but which affect proportionally significant or unique areas of agricultural resources.

These standards and practices for construction, cleanup and restoration of agricultural lands are for mineral soils only and, therefore, do not pertain to organic muckland soils. The New York State Department of Agriculture and Markets (Ag & Markets) recommends avoidance-routing around agricultural organic muckland soils. When this is not possible, project-specific development and implementation of agricultural mitigation techniques will be needed. The project sponsor's representatives should contact Ag & Markets during preliminary planning for such sites.

2.0 PLANNING

2.1 AGRICULTURAL AND SOIL CONSERVATION SPECIALIST/INSPECTOR

The Project Sponsor must retain a qualified Agricultural and Soil Conservation Specialist/Inspector (Agricultural Specialist) on each work spread for each phase: Environmental Management and Construction Plan (EM&CP) development, construction, initial restoration, post-construction monitoring and follow-up restoration. The Agricultural Specialist will submit site-specific agricultural information for EM&CP development to the Project Sponsor. This information will be obtained through field review as well as direct contact with affected farm operators, County Soil and Water Conservation Districts, Ag & Markets and others. The Agricultural Specialist will maintain regular contact with the Spread Environmental and Engineering Coordinators and appropriate on-site Project Inspectors throughout the construction phase. The Agricultural Specialist also maintains regular contact with the affected farmers and County Soil and Water Conservation Districts concerning farm resources and management matters pertinent to the agricultural operations and the site-specific implementation of the EM&CP. The Project Sponsor will consult with Ag & Markets at the same time they submit a request for an EM&CP modification concerning agriculture.

2.2 EM&CP MAPS

The Project Sponsor will provide on the general EM&CP plan maps the information described below concerning agricultural areas/uses.

2.2.1 Type of Agricultural Land and Facilities

- A. Pasture/Grazing
 - 1. Unimproved grazing areas (brushy or wooded land used by livestock)
 - 2. Permanent open pasture (land devoted only to pasture use, not suited to tillage rotation)
 - 3. Improved pasture (including tillable rotation pasture/hayland)
 - 4. Livestock fencelines

- B. Cropland
 - 1. Hayland
 - 2. Rotation cropland
 - 3. Long-term cropland (also includes agricultural lands enrolled in either the annual set-aside or the Conservation Reserve Program of the U.S.D.A. Consolidated Farm Service Agency). Such lands will be identified through consultation with the offices of the Consolidated Farm Service Agency and the County Soil and Water Conservation District.

- C. Unique Agricultural Lands (Avoidance routing strongly recommended)
 - 1. Specialty cropland (vegetables, berries, etc.)

2. Orchard
3. Vineyard
4. Maple Sugarbush
5. Organic Muckland
6. Permanent Irrigation systems

2.2.2 Vulnerable Agricultural Soils

Vulnerable agricultural soils are defined as areas of cropland, hayland, or pasture which are somewhat more highly sensitive than other agricultural soils to construction disturbance due to slope, relative soil wetness, and/or shallowness to bedrock. Wetness conditions are the result of factors such as landscape position, soil texture, seasonal water table and/or slowly permeable subsoil horizons (e.g., areas of laterally draining subsoils). All vulnerable agricultural soils including, but not limited to, those identified in the county soil survey as fragipans, lacustrines, dense basal tills, soils with a seasonally high water table, or soils with less than 5 feet of depth to bedrock are to be located and identified on the project map using the following codes:

- A. “VE” (designate the general area of vulnerability of erosion due to R-O-W factor(s) of slope and/or the texture of exposed soil).
- B. “V/W” (designate the general area of vulnerability to soil horizon wetness as described above).
- C. “V/B” (designate the general area of vulnerability due to shallow depth to bedrock).
- D. “V/OR” (designate the location of unavoidable organic mucklands).

2.2.3 Other Features

In addition, the Project Sponsor will provide the following information on the general EM&CP maps:

- A. Land and Water Management Features
 1. Subsurface drainage area (indicate each field)
 2. Open Ditch
 3. Diversion Terrace
 4. Buried water lines (farmstead consumptive use)
 5. Water source (developed springs, etc.)
 6. Unnamed water flow
- B. Depth of cover if it varies from the agricultural standard (refer to 2.7).
- C. Any off right-of-way access roads, work or storage areas. Map all such areas identified at the time of the EM&CP submission indicating their proposed locations and the location and size of all culverts to the extent

required. Any other areas that may be identified during construction will be considered and filed as a change in the EM&CP.

- D. The proposed location of any compressor stations, valve stations, metering and regulating stations and any other proposed facilities. Agricultural areas should be avoided when siting any above ground facilities.
- E. General locations for trench breakers, including a notation of the distance between breakers based on percent of slope, or an appended generic chart of trench breaker spacing by degree or percent of slope.
- F. General locations for subsurface intercept drains to control soil saturation and/or aid trench breakers in minimizing water piping, based on the vulnerable agricultural soils data (see Section 2.2.2) and site monitoring. Such locations will generally coincide with “V/W” vulnerable agricultural soils and breaks in slopes.

2.3 DOCUMENTATION OF IMPLEMENTATION PROCEDURES

The Project Sponsor will explain in the EM&CP narrative how the respective features of agricultural-related mitigation will be included in the contractual specifications or otherwise be carried out. The narrative will describe the method by which the Project Sponsor's staff and the contractor's field supervisors will be trained on the agricultural mitigation plan, which includes management criteria and designed standards and practices.

2.4 CHERRY TREE VEGETATION

The Project Sponsor will identify Black Cherry trees located on the right-of-way near active livestock use areas during EM&CP development. Black Cherry tree vegetation is toxic to livestock when cut and wilted and shall not be stockpiled in areas accessible to livestock. During the clearing phase, such vegetation will be disposed of in a manner which eliminates contact with livestock.

2.5 TRENCH CROSSINGS

The open trench will be fenced and temporary livestock and farm equipment crossings (or trench plugs) will be provided where requested and/or needed, by the farm owner/operator.

2.6 UNDERLAYMENT FOR ROCK/GRAVEL FILL

Where access ramps are required from the highway to the pipeline construction area in agricultural fields, an underlayment of durable, geotextile matting will be placed over the exposed subsoil surface prior to the use of temporary gravel access fill material. All such material will be removed upon completion of the project. The use of durable, geotextile matting as an underlayment helps prevent rock and stone from becoming embedded in the subsoil

material. Complete removal of the ramp upon completion of the project and restoration of the impacted site is required prior to topsoil replacement.

2.7 DEPTH OF COVER

2.7.1 Cropland, Hayland and Improved Pasture

In cropland, hayland and improved pasture a minimum depth of forty-eight inches of cover will be required; except where the new pipeline is located parallel and adjacent to an older existing pipeline that was buried with less than forty inches of cover. If such a situation occurs, a minimum depth of forty inches of cover will be required.

2.7.2 Unimproved Pasture

In unimproved grazing areas and land permanently devoted to pasture, a minimum depth of thirty-six inches of cover will be required.

2.7.3 Areas of Shallow Soil

In areas where the depth of soil over bedrock ranges from zero to forty-eight inches, the pipe shall be buried entirely below the top of the bedrock or at the depth specified for the particular land use (see 2.7.1 and 2.7.2), whichever is less. At no time will the depth of cover be less than twenty-four inches below the soil surface. All variances from this will be clearly stated in contract documents, construction drawings, or detailed drawings for special areas or crossings.

2.8 DRAIN LINE ALLOWANCE OF DEPTH

In existing agricultural fields where future surface and subsurface drainage plans have been identified by the owner/occupant or are on file with the Soil and Water Conservation District prior to EM&CP development, the Project Sponsor will provide adequate cover over the pipe to allow the future installation of major header drains and main drains across the right-of-way without obstruction due to the burial depth of the pipeline. It will be the responsibility of the Ag Specialist to determine the required elevations of the pipeline for clearance between the bottom of future drain systems and the top of the pipeline. Deviations to the standard depth of cover as detailed in section 2.7 will be specified in the EM&CP.

2.9 SUBSURFACE DRAIN REPAIR

During preparation of the EM&CP, a detailed drainage line repair procedure will be developed for the repair of crushed/severed clay tile and plastic drain lines. The procedure will be developed by the Ag Specialist in consultation with the local Soil and Water Conservation District. Specific drawings showing the generic technique to be implemented for drain line repairs will be provided by the Project Sponsor. The plan for the replacement of functional stone drainage systems severed during pipeline construction shall be prepared during the restoration phase by the Agricultural Specialist, in consultation with Ag & Markets and/or the Soil and Water Conservation District.

2.10 ALTERNATIVE GRAZING PLANS

The Ag Specialist(s) will work with the farm operators during the planning phase to develop a plan to delay the pasturing of the right-of-way, following construction, until pasture areas are adequately revegetated. The Project Sponsor will be responsible for maintaining the temporary fences on the right-of-way until the Ag Specialist determines that the vegetation on the right-of-way is established and able to accommodate grazing. At such time, the Project Sponsor will be responsible for the removal of the fences.

3.0 CONSTRUCTION/RESTORATION

3.1 CONTROL OF TRENCH WASHOUTS, WATER PIPING AND BLOWOUTS

Trench breakers are installed for the dual purpose of preventing trench washouts during construction and abating water piping and blowouts subsequent to trench backfill. The distance between permanent trench breakers may range from the relatively close-spaced formula of the toe of the upper trench breaker being level with the head of the lower trench breaker to the relatively greater spacing as detailed on the sample drawing “TRENCH BREAKER SPACING” or on the sample chart “PERMANENT SLOPE BREAKER SPACING”. The Project Sponsor will record each installed trench breaker location, by map referenced station-number.

3.2 TOPSOIL PROTECTION

In all agricultural portions of the right-of-way, topsoil will be removed from the subsoil stockpile area, trench, construction assembly and traffic zones. The depth of topsoil removal will include all of the “A” horizon down to the beginning of the subsoil “B” horizon, generally not to exceed a maximum of 12 inches. Topsoil removal up to a depth of 16 inches will be required in specially designated soils encountered along the pipeline route and identified in the EM&CP. All topsoil will be stockpiled and separated from other excavated materials. The Agricultural Specialist will determine depth of topsoil stripping per affected farm during EM&CP development by means of the County Soil Survey and on-site soil augering, if necessary. All topsoil material will be stripped, stockpiled, and uniformly returned to restore the original soil profile. During the clearing/construction phase, site specific depths of topsoil stripping will be monitored by the Agricultural Specialist. Where right-of-way construction requires cut-and-fill of the soil profile across grades, to the extent practicable, topsoil stockpiling will be located on the upslope edge of the right-of-way. Where topsoil cannot be separately stored on the upslope side, suitable right-of-way space will be provided on the downslope side to ensure the complete segregation of the topsoil from all cut-and-fill material.

Right-of-way width for agricultural lands will generally be the maximum necessary to allow adequate space for traffic, the trench and construction area, and the separate stockpiles of both topsoil and spoil material. Except in special conditions, such as road and stream crossings that may require a greater working area, the temporary right-of-way construction width should range from a minimum of 80 feet for a 12 inch diameter pipeline¹, to a maximum of 125 feet for a 36 inch diameter line. In projects using the relatively wide trenching method to meet construction worker safety requirements, a proportionally wider right-of-way will be temporarily acquired.

¹ The term “minimum” refers to the absolute minimum width of the temporary construction right-of-way, under the very best of working conditions: that is, a level farmscape on deep, well drained soil. An 80 feet width, however, is not adequate as the initial, “available width” through farmlands with mild, rolling or moderately steep slopes, nor on soils that are less than well drained or shallow to bedrock. In those situations, the minimum available width of temporary construction right-of-way should be 90 feet. This allows for the inherent cut-and-fill grading; the drift of wet subsoil muds/spoil materials; and the special concerns of shallow bedrock soils, without jeopardizing the protection of the stockpiled topsoil materials. Certain site-specific conditions may accommodate the farmland protection in a slightly narrower space, leaving some of the temporary right-of-way unused. Nevertheless, the availability of the 90 feet for the construction of a 12 inch pipeline should be provided for the temporary periods of construction and restoration.

3.3 SUBSOIL PROTECTION (SHALLOW SOILS)

Construction through farm soils dominated by a shallow depth to bedrock can result in a significant loss of, or permanent damage to, the subsoil or “B” horizon and corresponding damage to the soil profile, regardless of the measures employed to protect the topsoil (“A” horizon) material. The structure and thickness of the thin layer of remaining subsoil over bedrock can be adversely impacted as a result of grading, construction traffic and trench excavation as well as backfilling that involves bedrock material. The actual need for subsoil protection, as well as the method to be employed, must be based on project-specific factors including the diameter of the pipeline to be constructed, the site-specific depth to bedrock and the thickness of the subsoil. Among the construction phase measures that may help to minimize damages are:

- Stripping and separately stockpiling the “B” horizon of the right-of-way for a depth of 12 inches or to the top of the bedrock, whichever is shallower; or, stripping and separately stockpiling the “B” horizon from the full top width of the trench and spoil pile zone.
- Removing excavated bedrock materials from the site at the time of excavation.
- Backfilling the work trench with imported subsoil material.

3.4 BLASTING REQUIREMENTS

In agricultural areas of till over bedrock which requires blasting, the Project Sponsor will use matting or controlled blasting to limit the dispersion of blast rock fragments. Farm owners/operators will be given timely notice prior to blasting on farm property.

3.5 SUPPLEMENTAL BACKFILL MATERIALS

In agricultural areas where the materials excavated during trenching are insufficient in quantity to meet backfill requirements, the soil of any agricultural land adjacent to the trench and construction zone will not be used as either backfill or surface cover material. Under no circumstances will any topsoil material be used for pipe padding material or trench backfill. In situations where imported soil materials are employed for backfill on agricultural lands, such material shall be of similar texture to the existing soils on site.

In order to satisfy agricultural restoration requirements, a portion of a farm's non-cropland may, in some specific instances, be considered as an alternative source of imported soils.

3.6 BACKFILL PROFILE AND TRENCH CROWNING

In areas of cropland, including rotation hayland, permanent hayland and improved pastureland, ripped or blasted bedrock or concentrated volumes of excavated stone or rock material may be used for backfill, but no closer than twenty four (24) inches in mesic soils nor thirty (30) inches in frigid soils from the exposed working construction surface of the right-of-way. (To determine

the temperature regime of the soil, consult the U.S.D.A. Natural Resources Conservation Service, formerly S.C.S.). All excess rock not utilized as trench backfill will be hauled away. The remaining backfill materials will consist of suitable subsoil over the rock fill material. Trench crowning will occur during the backfill operation of the construction phase, using subsoil materials over the trench to allow for trench settling. The stockpiled topsoil will be spread over the entire affected right-of-way, after the initial ripping of the exposed subsoil and the rock cleanup has been completed. In areas where trench settling occurs after topsoil spreading, imported topsoil will be used to fill each depression. Topsoil from the right-of-way or from adjacent agricultural land will not be used to backfill depressions.

3.7 SUBSOIL RIPPING, STONE REMOVAL, TOPSOIL COVER AND SUBSOIL SHATTERING

In all agricultural sections of the right-of-way where topsoil is stripped, the Project Sponsor shall break up the exposed construction surface subsoil with deep tillage by such devices as a deep-ripper or heavy duty chisel plow. Following the deep ripping and chiseling, all stone and rock material four inches and larger in size which has been lifted to the surface shall be collected and taken off site for disposal. Upon approval of the subsoil decompaction and the stone removal by the Agricultural Specialist, the topsoil that has been temporarily removed for the period of construction shall then be replaced. Finally, deep subsoil shattering shall be performed with a subsoiler tool having angled legs. Stone removal shall be completed, as necessary, to eliminate any additional rocks and stones brought to the surface as a result of the final subsoil shattering process. Due to the generally unsuitable weather for continuing agricultural land restoration in late autumn, subsoil decompaction and topsoil replacement activities shall not be performed after October 1, unless approved on a site-specific basis by the certifying agency and Ag and Markets in consultation with the Agricultural Specialist.

4.0 TWO YEAR MONITORING AND REMEDIATION

The Project Sponsor will provide a monitoring and remediation period of no less than two years immediately following the full-length activation of the pipeline or the completion of initial right-of-way restoration, whichever occurs last. The two year period allows for the effects of climatic cycles such as frost action, precipitation and growing seasons to occur, from which various monitoring determinations can be made. The Project Sponsor will maintain a project work spread Agricultural Specialist on at least a part-time basis through this period. The monitoring and remediation phase will be used to identify any remaining agricultural impacts associated with right-of-way construction that are in need of mitigation and to implement the follow-up restoration.

4.1 GENERAL MONITORING AND REMEDIATION

General right-of-way conditions to be monitored include topsoil thickness, relative content of rock and large stones, trench settling, crop production, drainage and repair of severed fences, etc. Impacts will be identified through on site monitoring of all agricultural areas along the right-of-way and through contact with respective farmland operators and County Soil and Water Conservation Districts.

Topsoil deficiency and trench settling shall be mitigated with imported topsoil that is consistent with the quality of topsoil on the affected site. Excessive amounts of rock and oversized stone material will be determined by a visual inspection of the right-of-way and periodic probes of the trench area. Results will be compared to portions of the same field located outside of the right-of-way. Included in the determination of relative rock and large stone content is the right-of-way's condition subsequent to farm plowing/tillage and the relative concentration of such materials within the right-of-way as compared to off the right-of-way. All excess rocks and large stones will be removed and disposed of by the Project Sponsor.

On site monitoring shall be conducted at least three times during the growing season and shall include a comparison of growth and yield for crops on and off the right-of-way. When the subsequent crop productivity within the affected right-of-way is less than that of the adjacent unaffected agricultural land, the Agricultural Specialist, in conjunction with the Project Sponsor as well as other appropriate organizations, will help to determine the appropriate rehabilitation measures for the Project Sponsor to implement. During the various stages of the project, all affected farm operators will be periodically apprised of the duration of remediation by their respective work spread Agricultural Specialist. Because conditions which require remediation may not be noticeable at or shortly after the completion of construction, the signing of a release form prior to the end of the remediation period will not obviate the Project Sponsor's responsibility to fully redress all project impacts. After completion of the specific remediation period, the Project Sponsor will continue to respond to the reasonable requests of the farmland owner/operators to correct project related affects on the impacted agricultural resources.

4.2 SPECIFIC MONITORING AND REMEDIATION

4.2.1 Compaction Testing and Remedial Action

After the moisture of the soil profile on the affected right-of-way has returned to equilibrium with the adjacent off right-of-way land, subsoil compaction will be tested using an appropriate soil penetrometer or other soil compaction measuring device. Compaction tests will be made for each soil type identified on the affected agricultural fields. The subsoil compaction test results within the right-of-way will be compared with those of the adjacent off right-of-way portion of the affected farm field/soil unit. Where representative subsoil density on the right-of-way exceeds the representative subsoil density outside the right-of-way, additional shattering of the soil profile will be performed using a deep, angled-leg subsoiler tool. Deep shattering will be applied during periods of relatively low soil moisture to ensure the desired mitigation and to prevent additional subsoil compaction. Oversized stone/rock material which is uplifted to the surface as a result of the deep shattering will be removed. In the event that subsequent construction or clean-up activities result in new compaction, additional deep tillage will be performed to alleviate such compaction.

4.2.2 Control of Soil Saturations and Seeps

For lands disturbed within or adjoined to agricultural areas where the construction alters the natural stratification of soil horizons and natural soil drainage patterns, the Project Sponsor will rectify the effects with measures such as subsurface intercept drain lines. Selection of the type of intercept drain lines to install to prevent surface seeps and the seasonally prolonged saturation of the backfilled trench zone and adjacent areas will be performed by a qualified Agricultural Specialist. Drawings of such drain locations will be provided by the Project Sponsor during monitoring and follow-up remediation. All drain lines will be installed according to Natural Resource Conservation Service (formerly SCS) standards and specifications.

4.3 COMMUNICATION ACCESS

The Project Sponsor will provide all farm owners/operators with a telephone number to facilitate direct contact with the Project Sponsor and the project's Agricultural Specialist(s) through all of the stages of the project, including operation and maintenance.

*INTERCEPT TILE
CROSS-TRENCH*

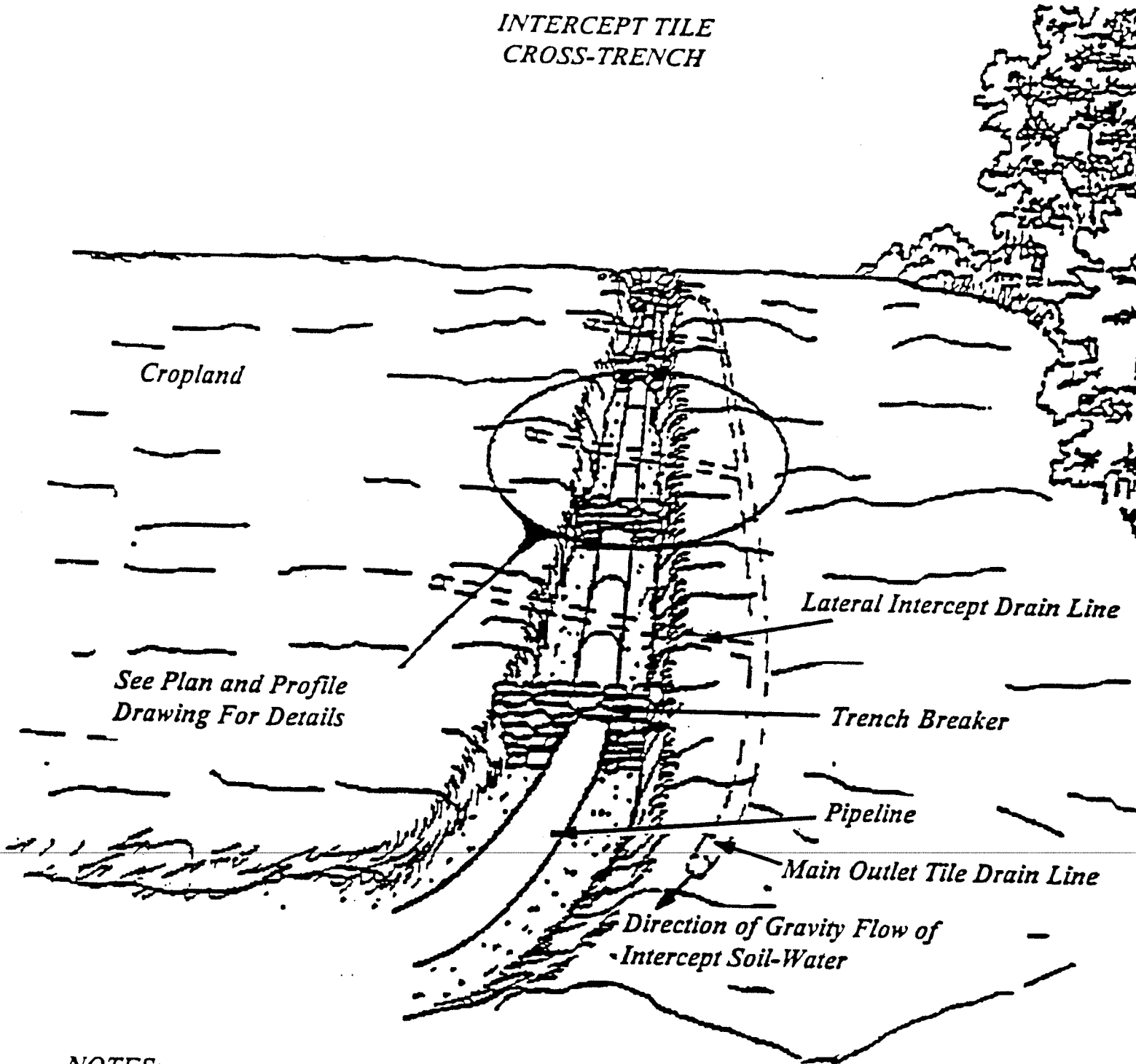

NOTES:

- 1. Cross trench drainage may be utilized in sloping areas or in agricultural cropland areas where required.*
- 2. Final alignment of tile lines to be based on outletting for gravity flow.*
- 3. See SAMPLE A-2 drawing for plan and profile.*

*SAMPLE
A-1*

**INTERCEPT TILE
CROSS-TRENCH**

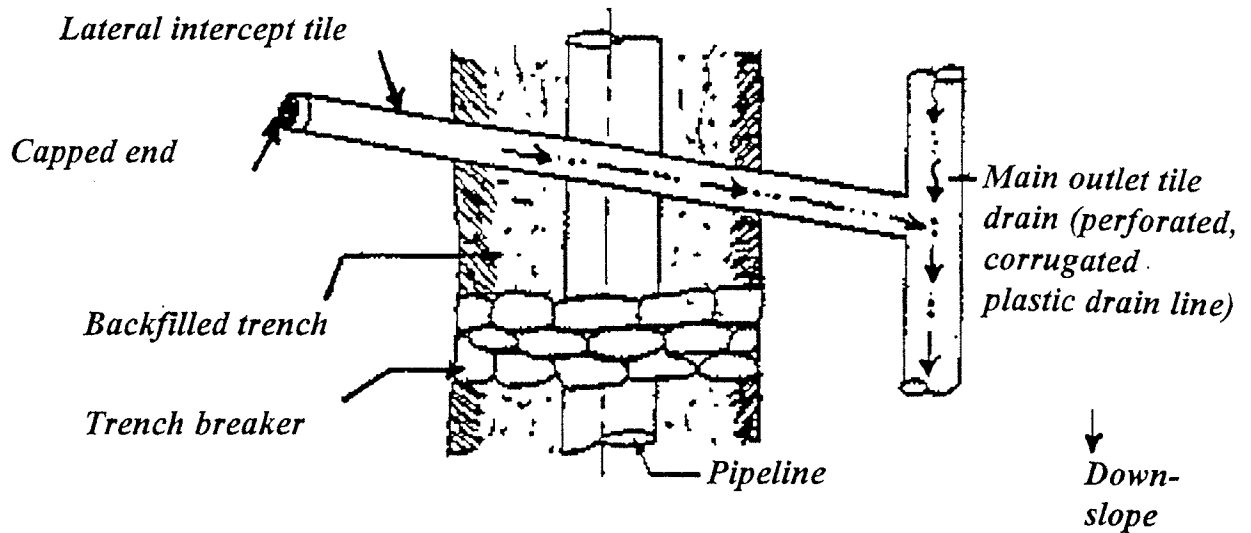

PLAN - SECTION A-A

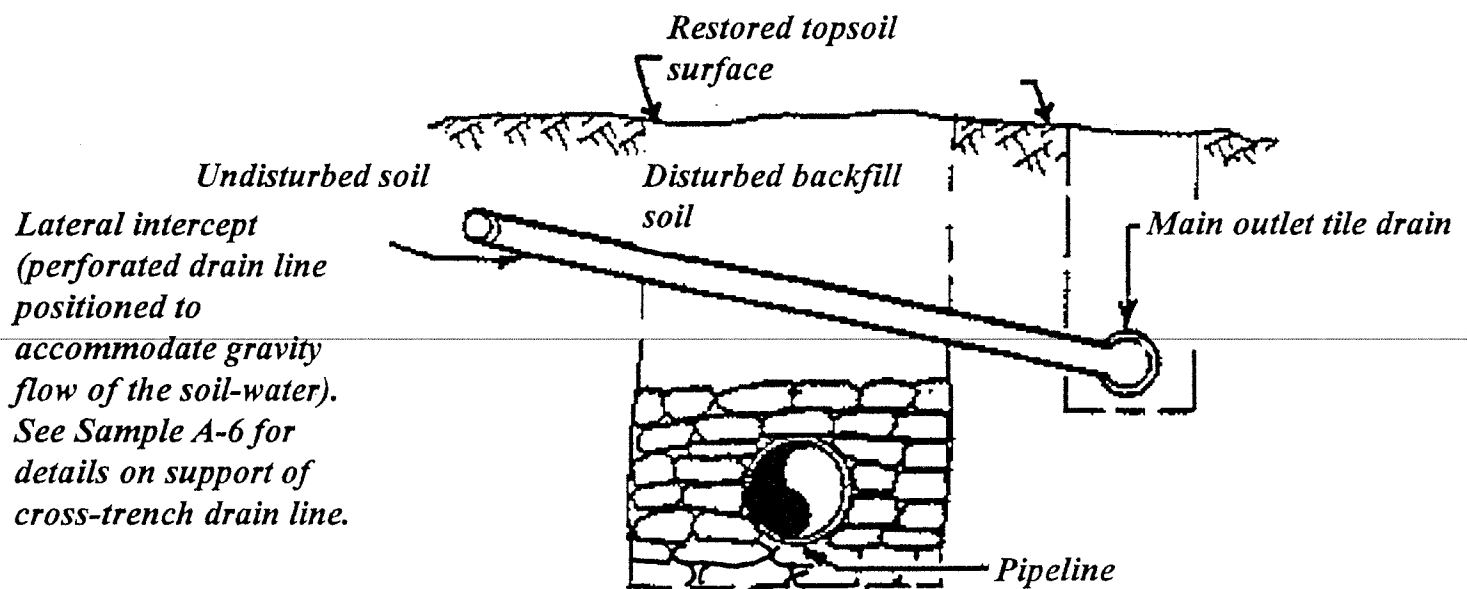

PROFILE - SECTION A-A

NOTES:

1. *Trench breakers prevent gully erosion while trench is open and inhibit water piping and water blowouts down the course of the pipeline after backfilling.*
2. *Intercepting drain lines absorb the soil-water seepages which drain naturally from the undisturbed soil profile into the disturbed backfill soil material of the trench. The intercept drain lines help prevent saturated soil conditions.*
3. *Agricultural drainage may require either or both cross trench drainage and parallel trench drainage for controlling soil saturation.*

INTERCEPT TILE

PARALLEL

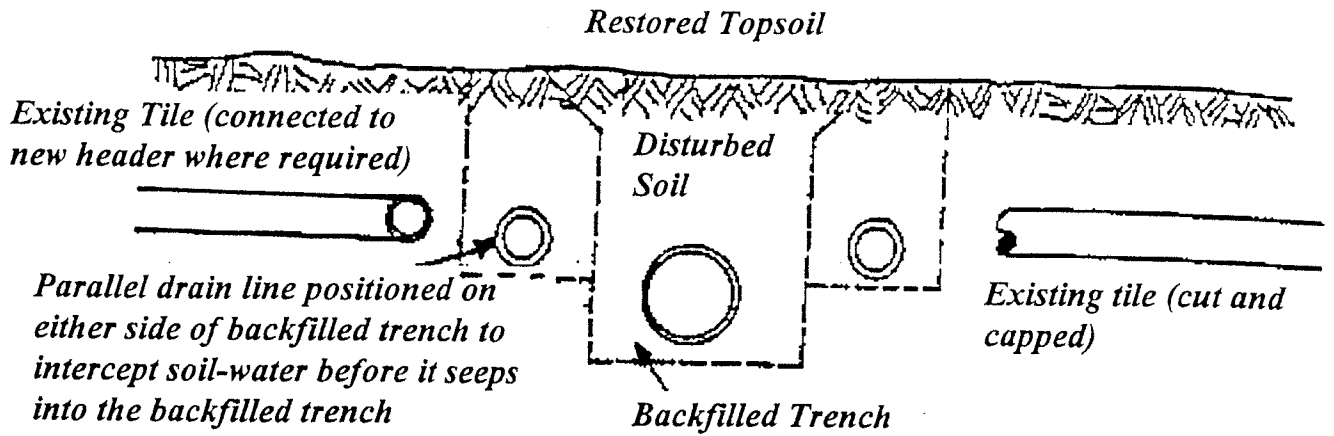

NOTE:

1. Parallel drain tile installation to be approved for site specific agricultural soils where repair of existing cross tiles would be less effective.

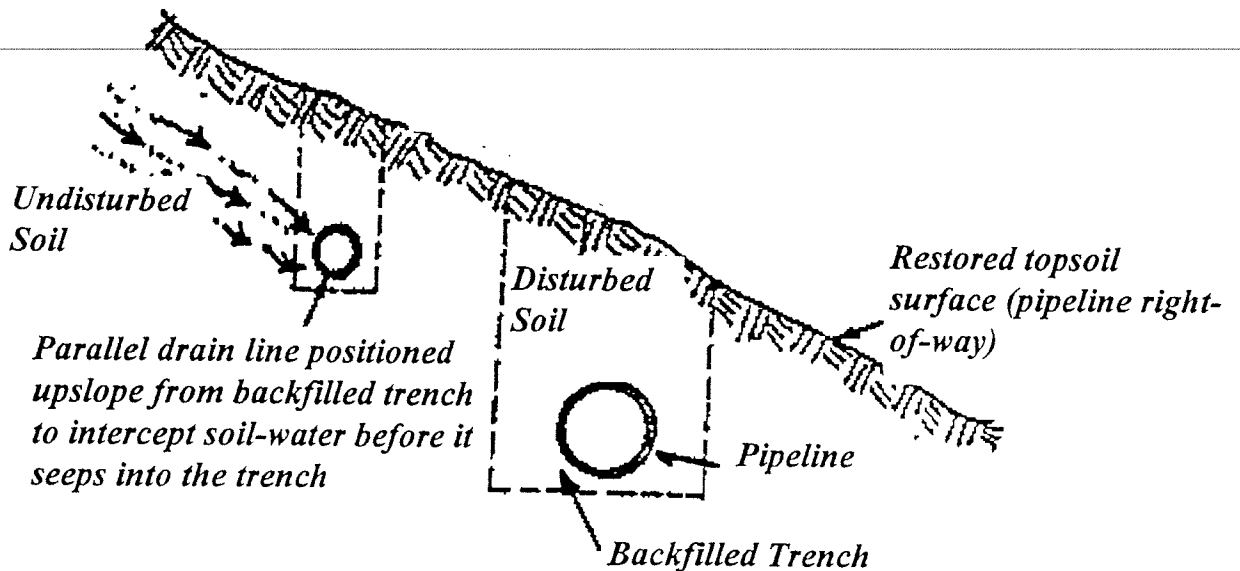

NOTE:

1. Parallel drain tile installation to be approved for site specific locations based on soil characteristics and slope conditions.

SAMPLE

DRAIN TILE PROBE

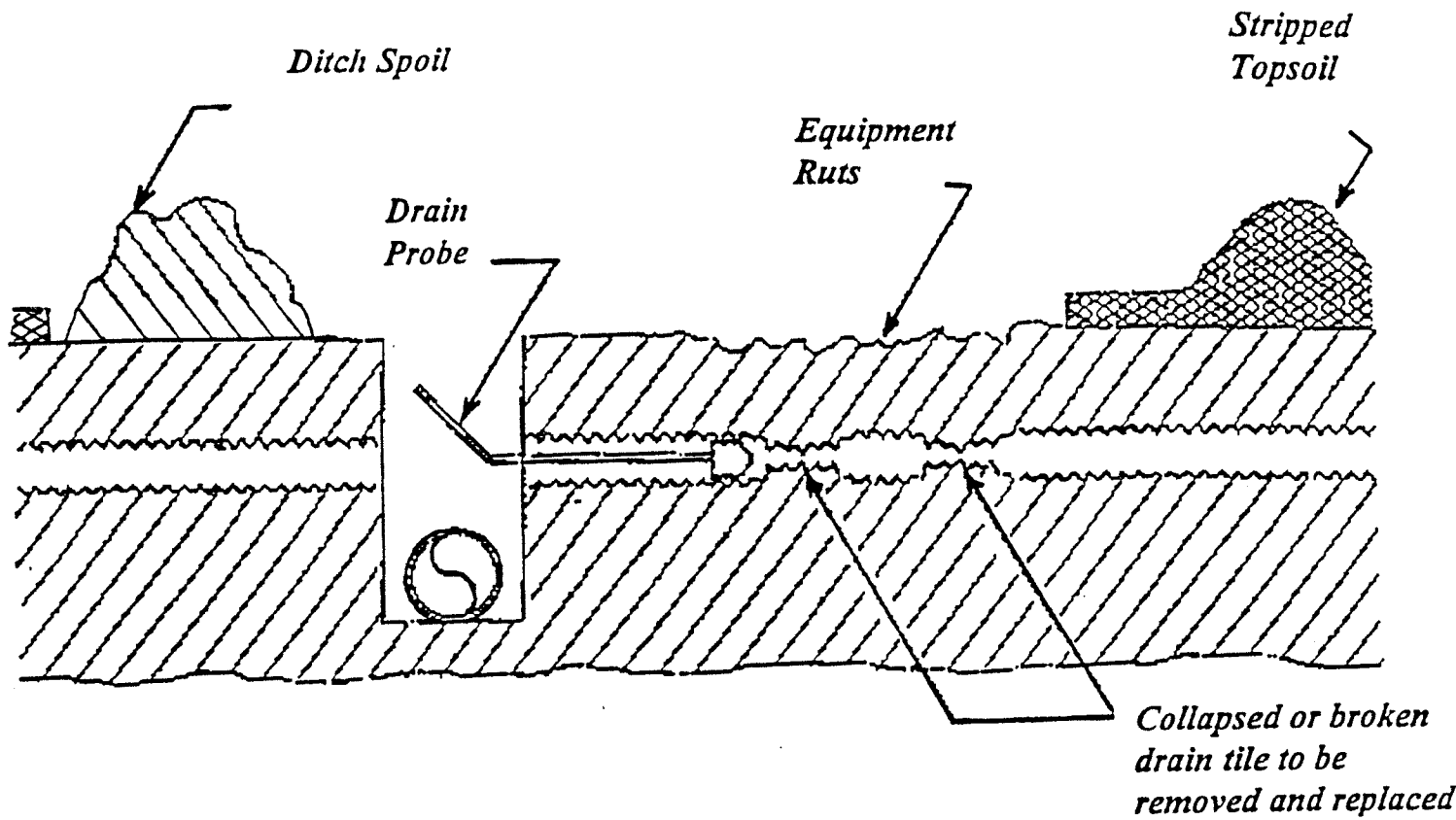

NOTES:

1. Clean out drain tiles to the permanent R-O-W limit on the working side.
2. Replace damaged tiles and repair tiles and joints that require work and are within the areas of construction activities.

SAMPLE

A-4

REPAIR OF SEVERED TILE LINE

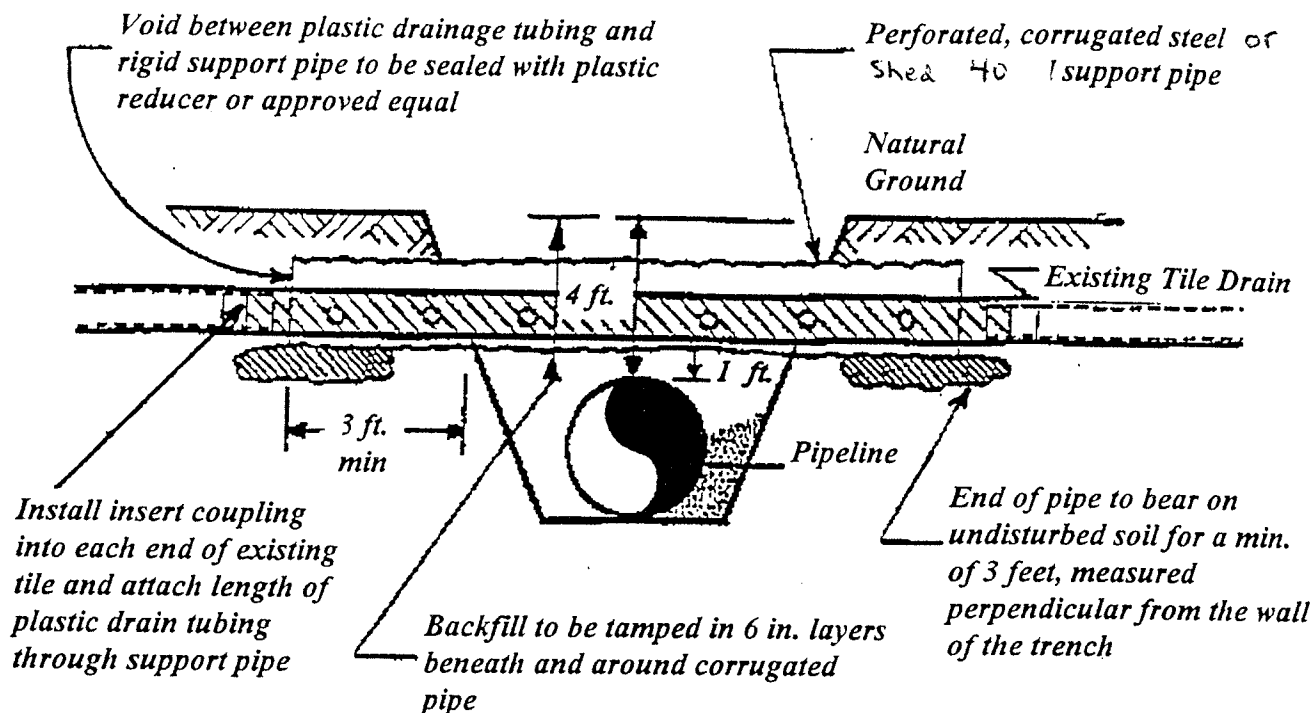

Tubing size	Corrugated pipe size
4"	6"
6"	8"
8"	10"
10"	12"
12"	18"
18"	20"

NOTES:

1. All corrugated pipe to be 16 gauge steel.
2. Plastic drain tubing and corrugated pipe to be installed so the holes are centered on each side of the bottom of the pipe.
3. All material to be contractor supplied.
4. The perforated rigid support pipe is shouldered back into the firm, undisturbed soil profile to ensure consistent gravity flow gradient of the tile line across the trench as the backfill material gradually settles for up to two years.

SAMPLE

REPAIR OF SEVERED DRAIN TILE

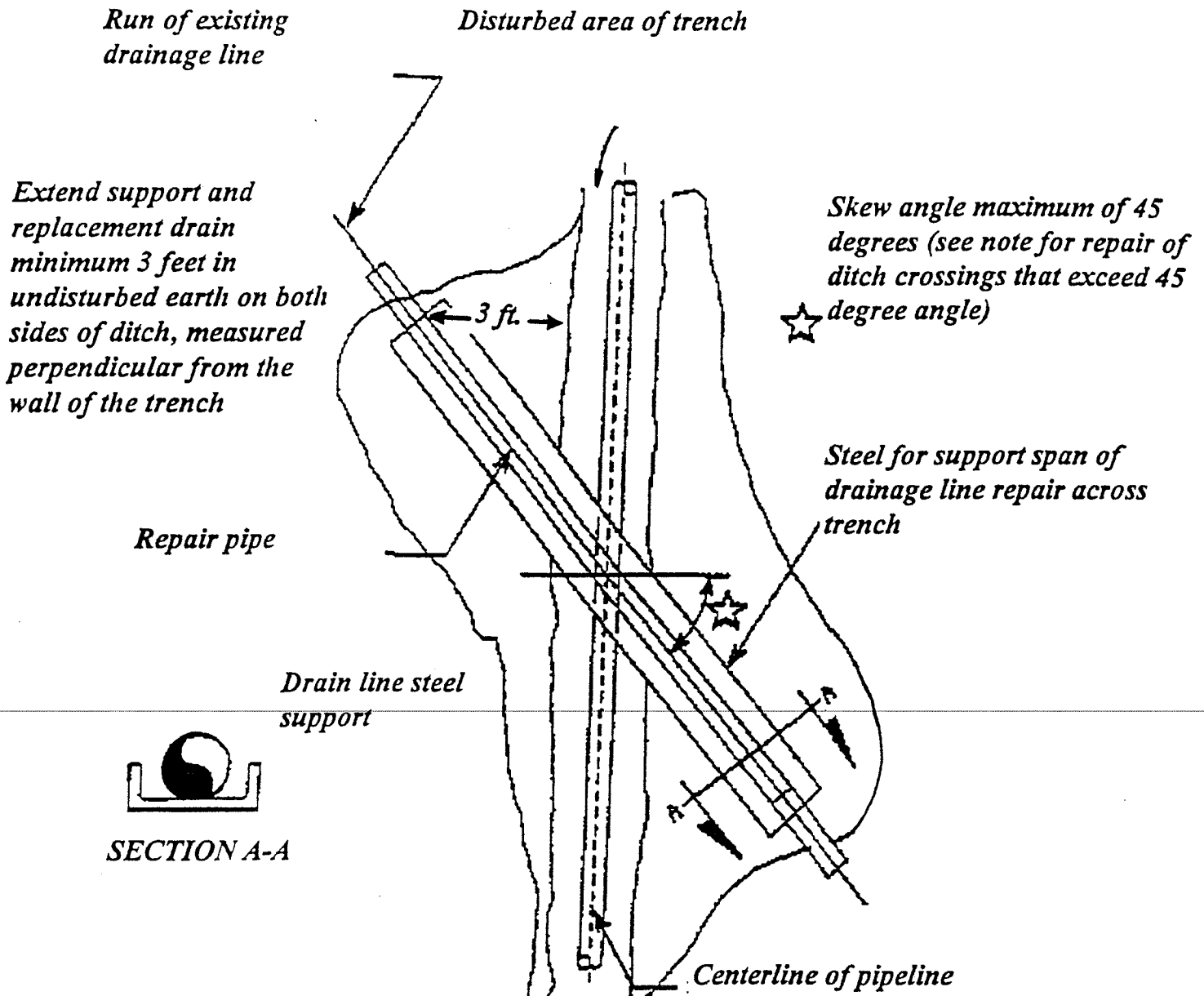

NOTES:

1. Provide a steel support for drain tile or plastic pipe to maintain function while ditch is open.
2. Should a drain tile cross a ditch at a skew of greater than 45 degrees, the replacement drain is to be relocated into undisturbed soil or out of conflict with the pipeline ditch. Replacement drain line is to be installed to match elevation of existing drain tiles.

SAMPLE
A-6

*CONSTRUCTION AND RESTORATION SEQUENCE
THROUGH AGRICULTURAL SOILS*

Topsoil stripping and trenching

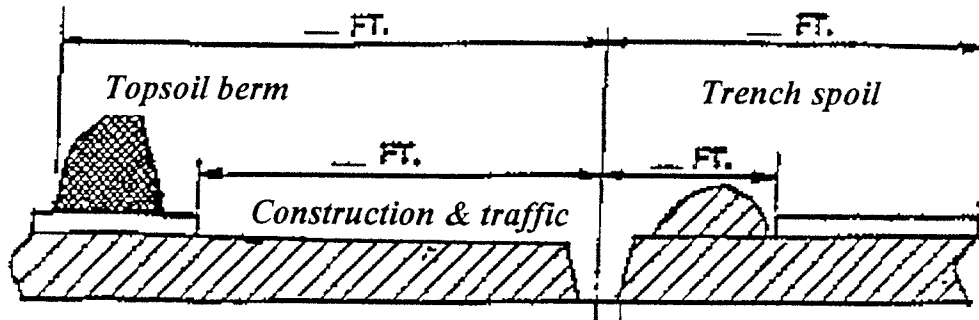

* *Backfilling*

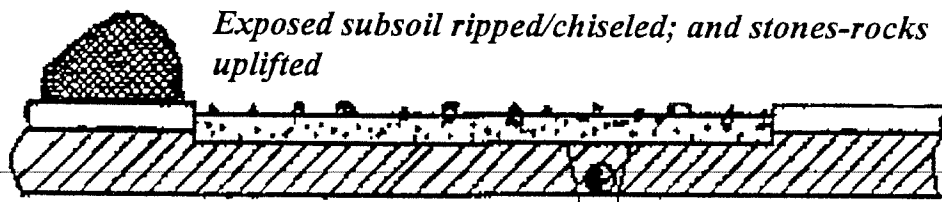
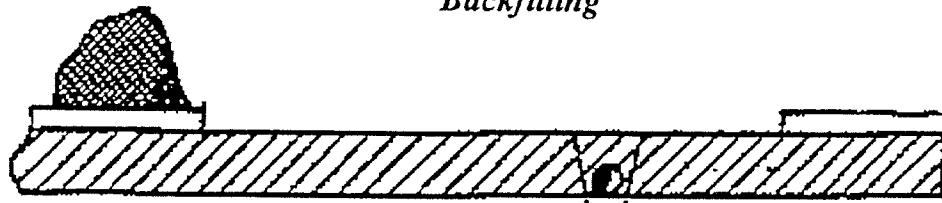

Stone removal

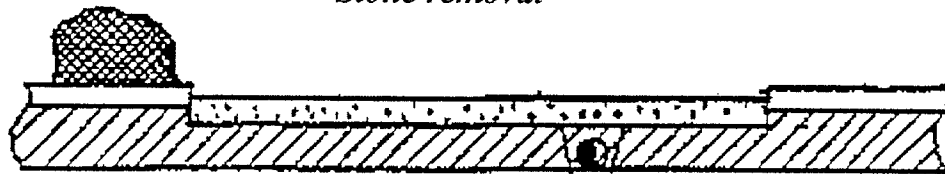

**Restoration of topsoil and deep, angled-leg shattering of the subsoil*

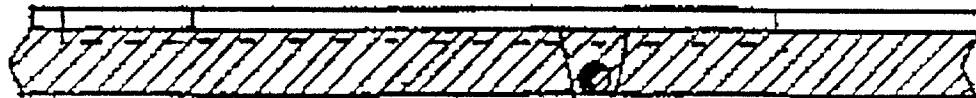

NOTES:

1. *Additional temporary area for topsoil stockpiles may be required on either side of the right-of-way (additional area to be identified on site-specific basis).*
2. **Trench crowning not shown in this illustration due to relative scale.*

SAMPLE

A-7

TRENCH CROWNING SEQUENCE

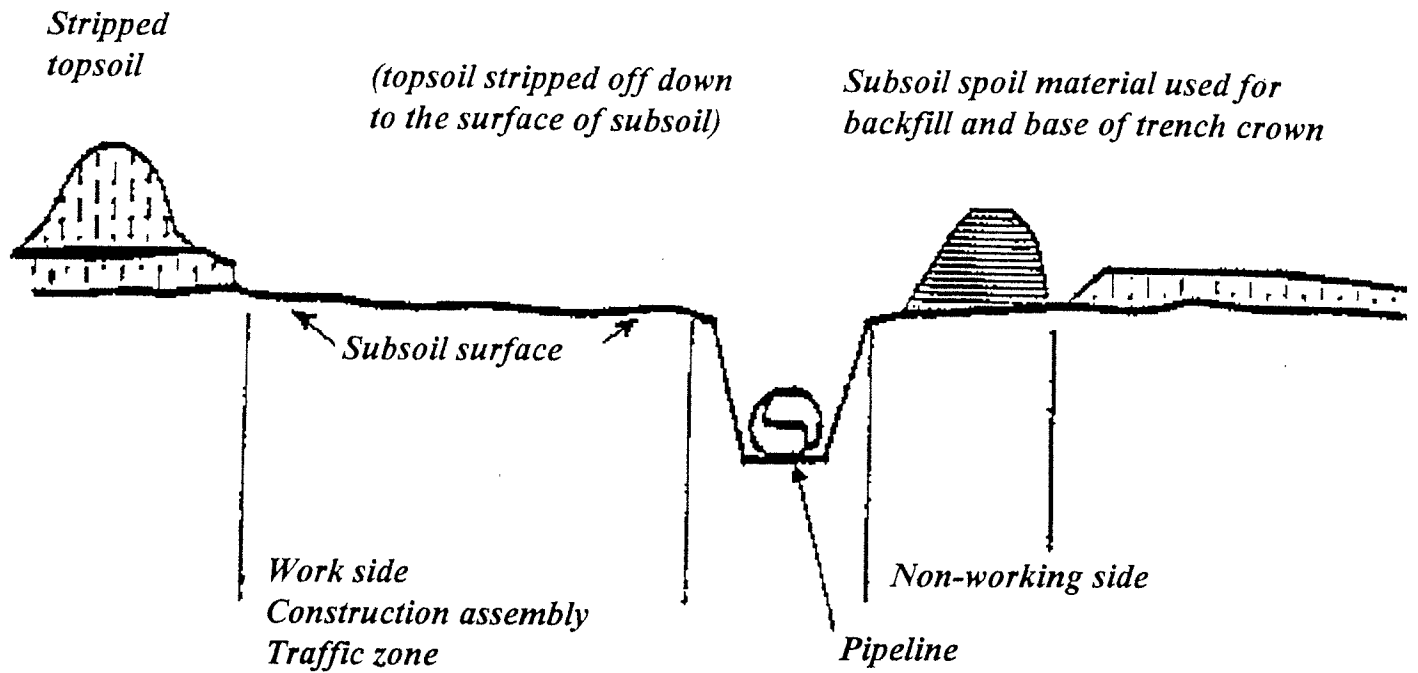

After -

The trench is backfilled and semi-crowned with spoil, the exposed subsoil of the right-of-way is ripped and chiseled, and the uplifted stones and rocks are removed;

Then...

The stripped topsoil is replaced across the right-of-way, uniformly over the crowning of subsoil over the trench to allow for settling; and, final deep-shattering of the subsoil is applied with a deep, angle leg subsoiler

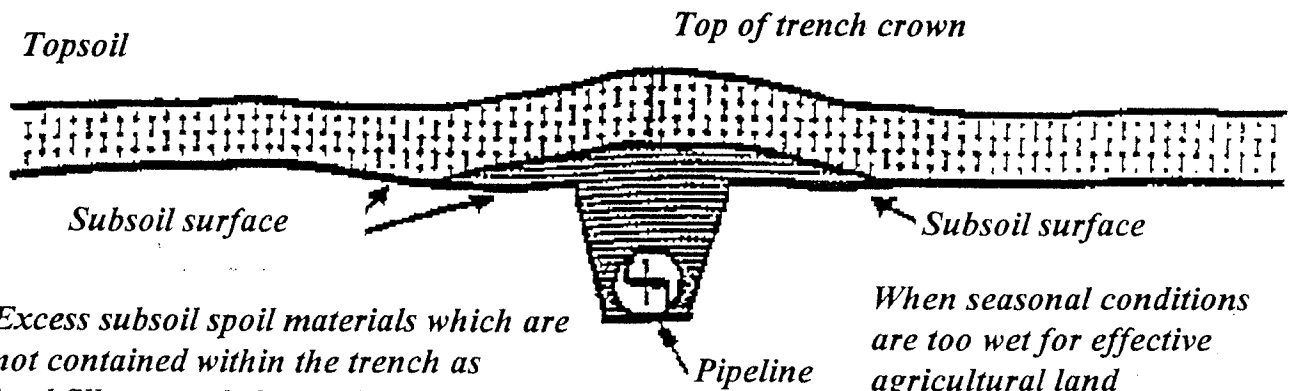

Excess subsoil spoil materials which are not contained within the trench as backfill are graded over the exposed subsoil surface not over the topsoil.

When seasonal conditions are too wet for effective agricultural land restoration, the trench is backfilled and the work site is "winterized" and further restoration is postponed.

SAMPLE

A-8

DEPTH OF TOPSOIL REMOVAL

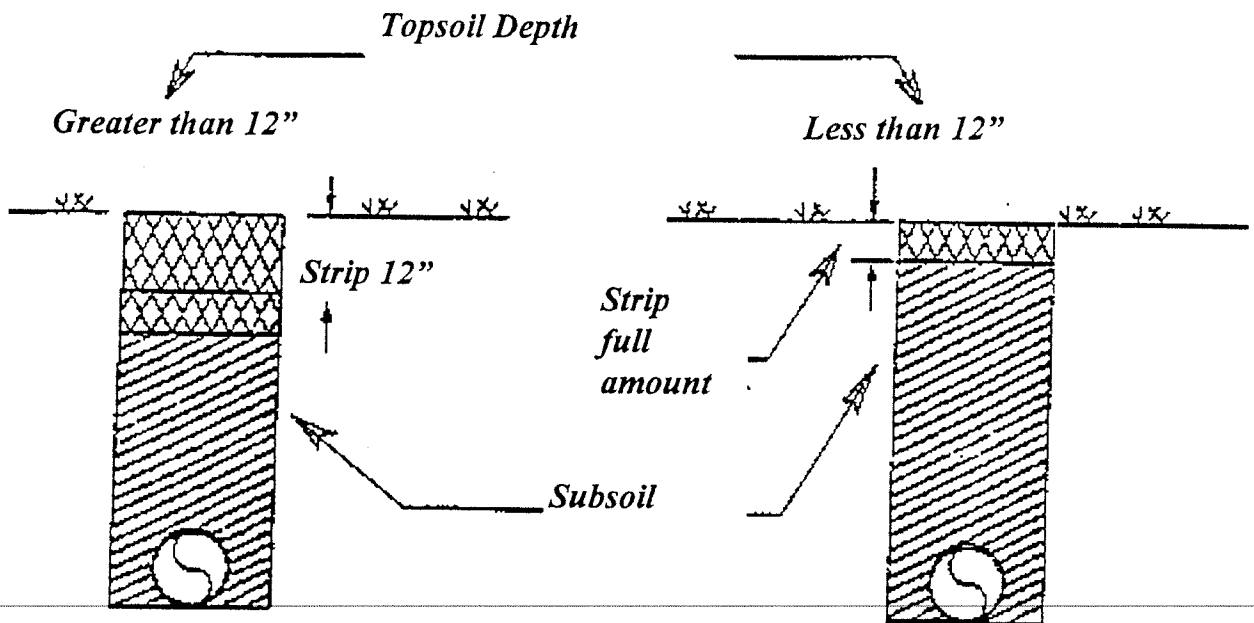

NOTE:

1. In instances where the topsoil is very finely textured and is deeper than 12 inches, stripping down to the depth of the subsoil or 16 inches, whichever is less, may be required.

SAMPLE

A-9

TOPSOIL STOCKPILING ON SLOPES

REQUIRING CUT AND FILL GRADE

In situations where R-O-W crosses agricultural slopes and construction cuts/grading will occur, stockpile all topsoil on upslope edge of R-O-W to prevent burying and mixing of topsoil. If topsoil must be stockpiled on the Downslope side, plan extra work space to ensure complete separation of topsoil and subsoil stockpiles

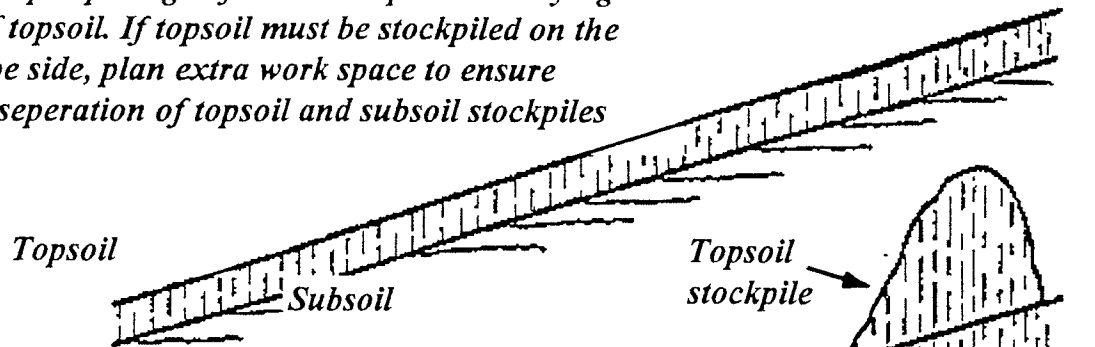

Topsoil stripped from full-width and stockpiled on upslope edge

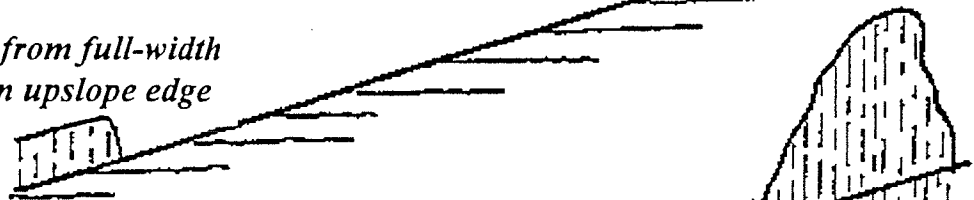

Cut-and-fill using only subsoil materials over subsoil

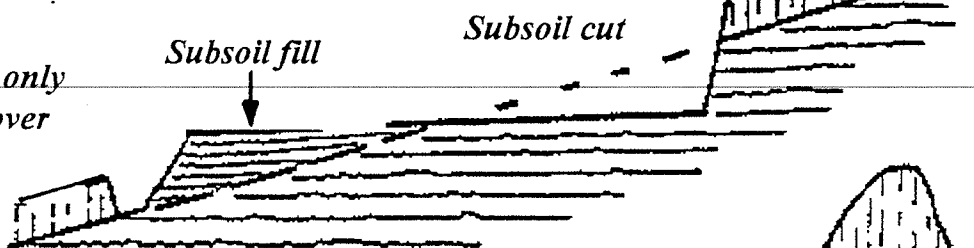

Trench subsoil spoil is stockpiled on top of subsoil.

(It is preferable for bedrock and boulder spoil to be temporarily piled in access lane for immediate removal)

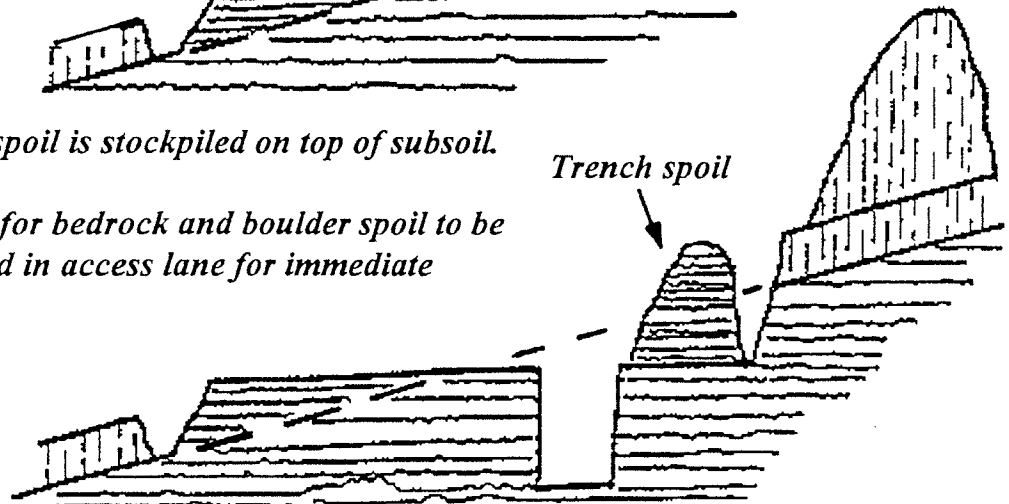

NOTES:

1. Subsoil is regraded to contour after pipe installation.
2. Topsoil is replaced over the R-O-W after the subsoil is decompacted and rocks/stones are removed.

SAMPLE

A-10

MINIMUM PIPELINE DEPTH OF COVER FOR AGRICULTURAL LAND

1. NON BEDROCK CONDITIONS

Cropland, Haylands, Rotation Land, Improved Pasture

Unimproved Pasture and Other Areas

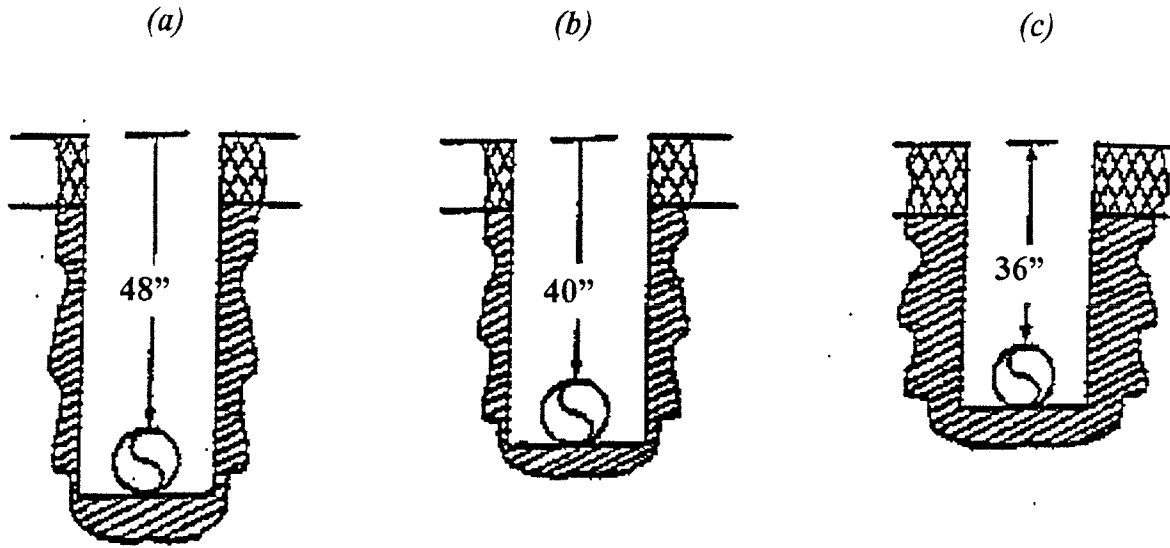

(a) *Pipe is the only pipeline on the right-of-way or is adjacent to existing pipeline with 40" or more depth of cover*

(b) *Pipe laid parallel and adjacent to an existing pipeline which has less than 40" depth of cover (except special areas as noted on construction drawings)*



Topsoil



Subsoil

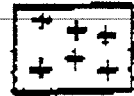

Bedrock

2. BEDROCK CONDITION *

Bedrock less than 24" from surface

Bedrock between 24"-48" from surface

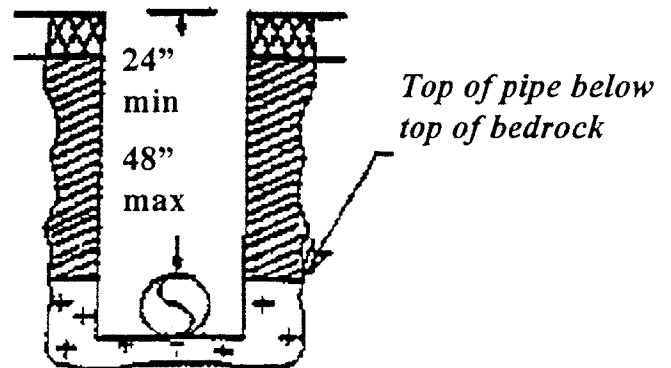
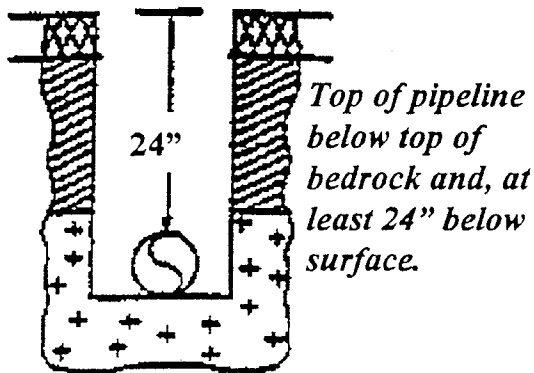

** Except where deeper burial depths are required by certifying agency or commission, etc.*

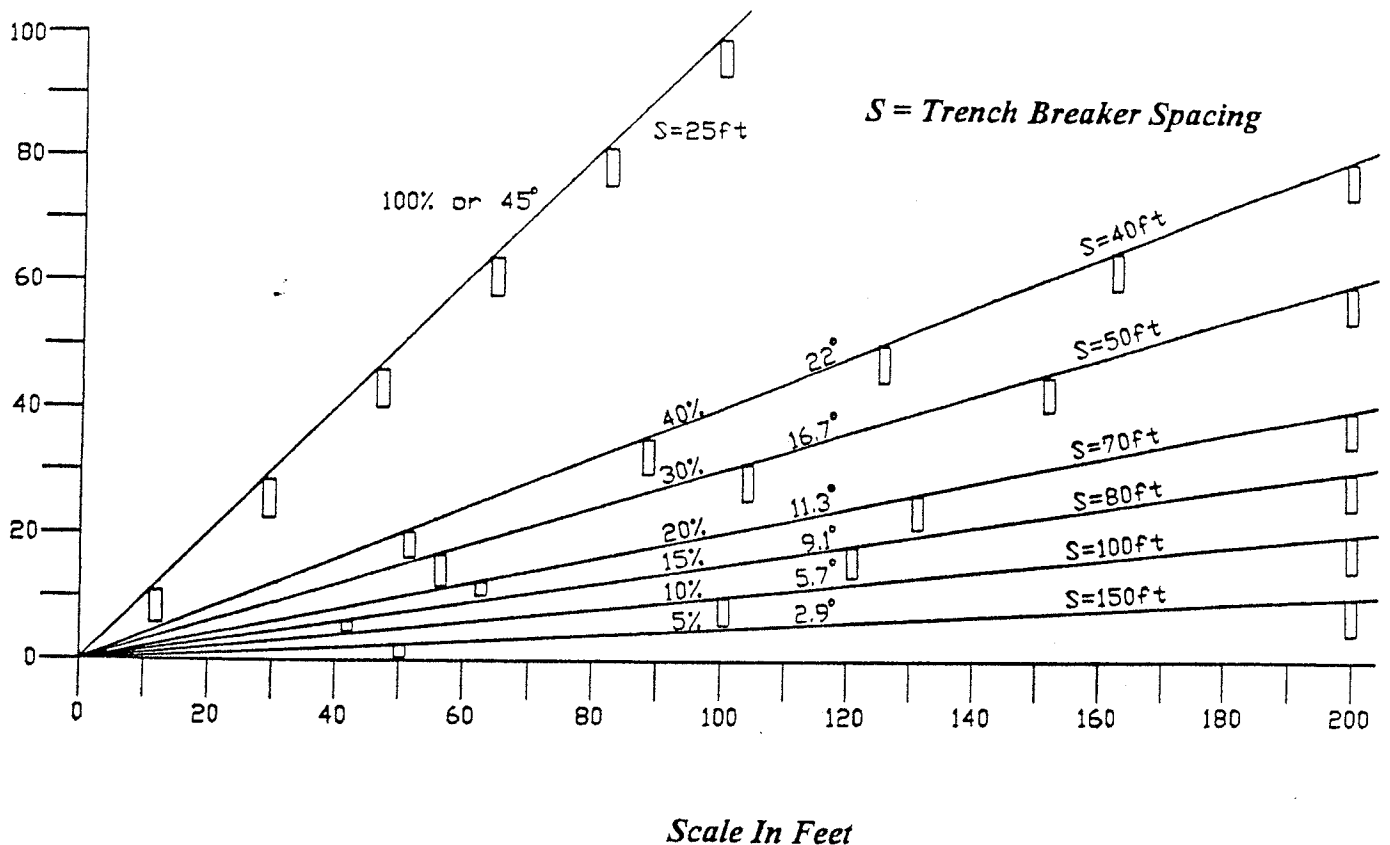

TRENCH BREAKER SPACING

NOTES:

1. Depending on site specific conditions of slopes exceeding 40%, the spacing between trench breakers may continue diminishing as illustrated, or may cease diminishing once a spacing of 30 to 35 feet has been reached.
2. The preferred construction material for trench breakers is sand bags, which are durable yet flexible and will conform to gradual shifting of pipeline and backfill, while serving their function: impede the flow of subsurface water along the trench.
3. In agricultural lands, top of trench breaker will not be closer than two feet from the restored surface.

**SAMPLE
A-12**

**PERMANENT SLOPE BREAKER SPACING
AS ALTERNATIVE SPACING GUIDELINE FOR TRENCH BREAKERS¹**

<u>SLOPE (PERCENT)</u>	<u>SPACING (FEET)</u>
<5	125
5 TO 10	100
10 TO 20	75
20 TO 35	50
>35	25

Source: New York Guidelines for Urban Erosion and Sediment Control (October 1991)

"Standards and Specifications for Water Bars," with the terms "Slope Breaker" and "Water Bar" being synonymous: "A ridge or ridge and channel constructed diagonally across a sloping road or utility right-of-way that is subject to erosion."

¹ Basis of Permanent Slope Breaker Spacing as an Alternative Spacing Guideline for Trench Breakers is found in U.S. Federal Energy Regulatory Commission's 12/2/94 Upland Erosion Control, Revegetation and Maintenance Plan, VI. Restoration, B. Permanent Erosion Control Devices (pp. 8 and 9)

SANDBAG TRENCH BARRIERS (with trench-floor breakers)

ALTERNATIVE SPACING¹

<u>Trench slope</u>	<u>Spacing between full barriers</u>	<u>Spacing between trench-floor breakers</u>
<5%	NONE (no full barrier)	15 feet
5-15%	300 feet	15 feet
15-30%	200 feet	15 feet
>30%	100 feet	15 feet

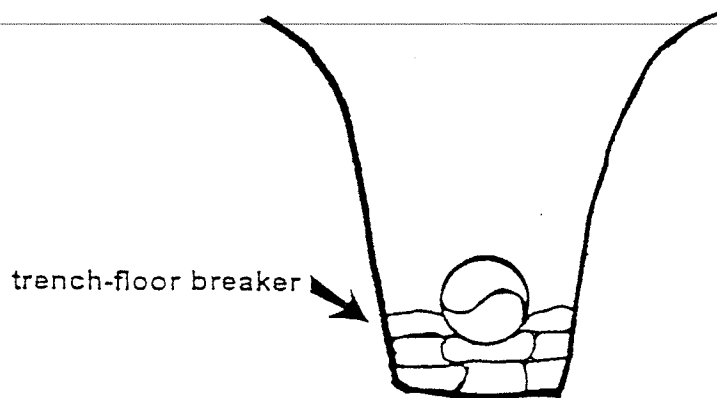

¹ This "alternative spacing" chart is provided as a supplement to Sample A-12 and Sample A-13 in Pipeline Right-of Way Construction Projects -- Agricultural Mitigation Through the Stages of Project Planning, Construction/Restoration and FollowUp Monitoring, by the New York State Department of Agriculture and Markets.

LEGEND - AGRICULTURAL AND RELATED SYMBOLS

Examples For Environmental Management and Construction Practices (EM&CP) Plan and Profile Maps

C	<i>Cropland *</i>
C-U	<i>Cropland - unique (orchards, vegetables, ornamental, vineyard, etc.)</i>
- or -	
C-U/1	<i>Cropland, unique - orchards or vineyards</i>
C-U/2	<i>Cropland, unique - vegetables or berries</i>
C-U/3	<i>Cropland, unique - ornamental (nurseries, Christmas trees)</i>
C-V/E	<i>Cropland, vulnerable - erosion</i>
C-V/W	<i>Cropland, vulnerable - wetness</i>
C-V/E,W	<i>Cropland, vulnerable - erosion and wetness</i>
C-V/OR	<i>Cropland, vulnerable - organic muckland</i>

* **"Cropland"** includes not only long term croplands, rotation cropland, and tillable lands enrolled in USDA "set aside" or "conservation easement" programs but also includes **"Hayland"**. If separate identification of hayland is desired, then the following agricultural symbols may be used:

H	<i>Hayland</i>
H-V/E	<i>Hayland, vulnerable - erosion</i>
H-V/W	<i>Hayland, vulnerable - wetness</i>
H-V/E,W	<i>Hayland, vulnerable - erosion and wetness</i>

LEGEND - AGRICULTURAL AND RELATED SYMBOLS (continued)

<i>P1</i>	<i>Improved pasture</i>
<i>P1-V/E</i>	<i>Improved pasture, vulnerable - erosion</i>
<i>P1-V/W</i>	<i>Improved pasture, vulnerable - wetness</i>
<i>P2</i>	<i>Native pasture, unimproved</i>
<i>P3</i>	<i>Wooded pasture</i>
<i>SGB</i>	<i>Sugarbush, maple syrup production</i>
<i>AF</i>	<i>Abandoned field</i>
<i>F/TM</i>	<i>Forest or woodlot with ongoing timber management</i>
<i>F/UM</i>	<i>Forest or woodlot without ongoing timber management</i>
<i>EX</i>	<i>Excavated area</i>
<i>*BDR*1</i>	<i>Bedrock within thirty inches of surface</i>
<i>*BDR*2</i>	<i>Bedrock thirty to forty-eight inches from the surface</i>
<i>*BDR*3</i>	<i>Bedrock forty-eight to sixty inches from the surface</i>
<i>—DV—</i>	<i>Existing diversion terrace</i>
<i>—T—</i>	<i>Existing tile drain line - plastic, clay, stone (indicate each field)</i>
<i>—ITS—</i>	<i>Intercept tile drain lines (cross trench, and/or parallel) likely needed to control seepage</i>
<i>OD</i>	<i>Open ditch, existing</i>
<i>WTL</i>	<i>Water line, existing</i>
<i>IRG</i>	<i>Buried irrigation line, existing</i>
<i>TFL</i>	<i>Temporary fenceline needed</i>
<hr/>	
<i>--x--</i>	<i>Permanent fence, existing</i>
<i>O</i>	<i>Well or spring, existing</i>
<i>SPS</i>	<i>Septic system, existing</i>

Note: For definitions of "cropland", "hayland", "pastureland" and cropland in vulnerable categories, refer to respective discussions in text of PIPELINE RIGHT-OF-WAY CONSTRUCTION PROJECTS - AGRICULTURAL MITIGATION. For information on intercept drain lines refer to respective discussions on vulnerable soils, site restoration and appended illustrations.